

ADANLOCK ARCHITECTURAL WALL SYSTEMS

478 SERIES - STANDARD DETAILS

VERTICAL
MULLION
POSTS

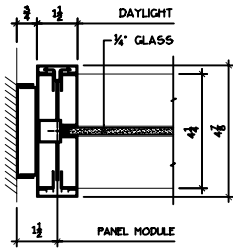

GLASS PANEL WALL STARTER

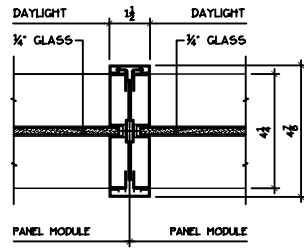

GLASS PANEL - INTERMEDIATE MULLION

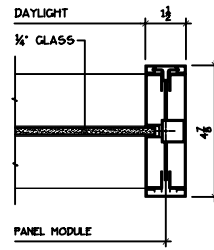

GLASS PANEL - FINISHED END POST

DOOR
FRAME
JAMBS

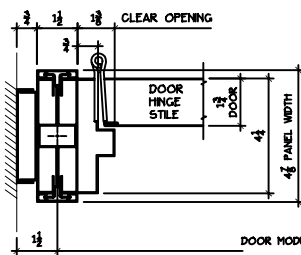

DOOR FRAME AT WALL START

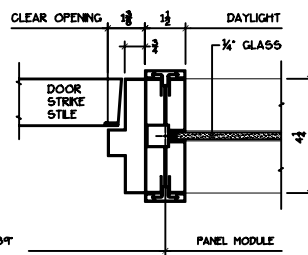

DOOR FRAME AT GLASS PANEL

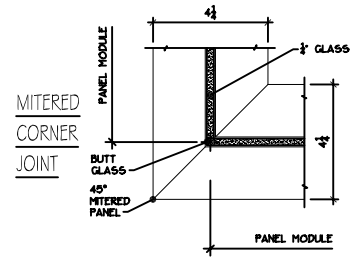

MITERED
CORNER
JOINT

BUTT-END GLASS
MITERED JOINT

GLASS PANEL DETAILS

CORNER
POST
DETAILS

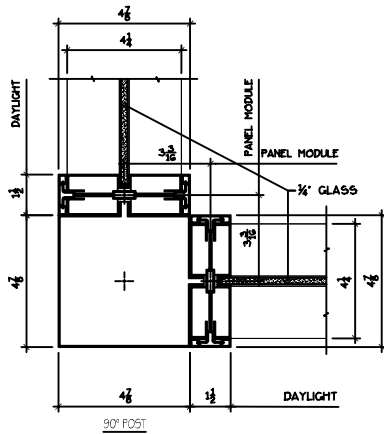

90° POST

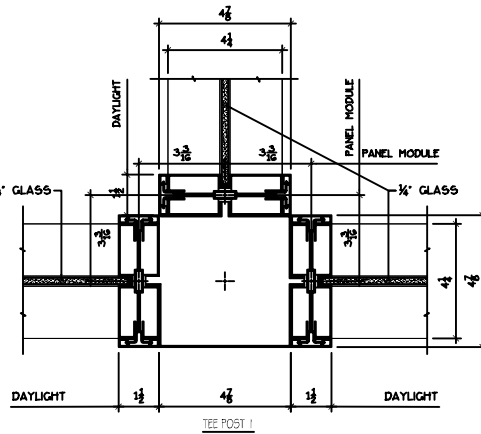

TEE POST 1

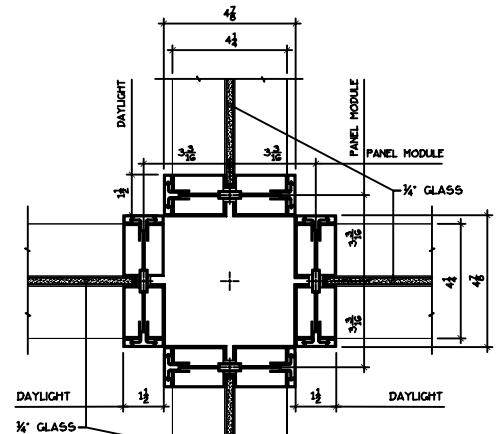

4-WAY POST

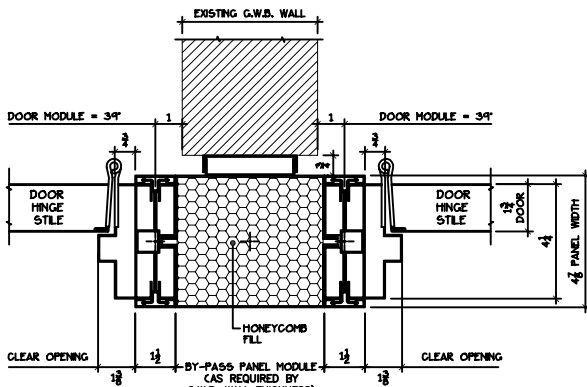

BY-PASS PANEL AT DOOR FRAMES

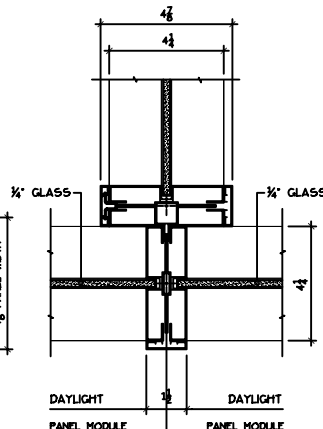

TEE POST 2

BY-PASS
PANEL

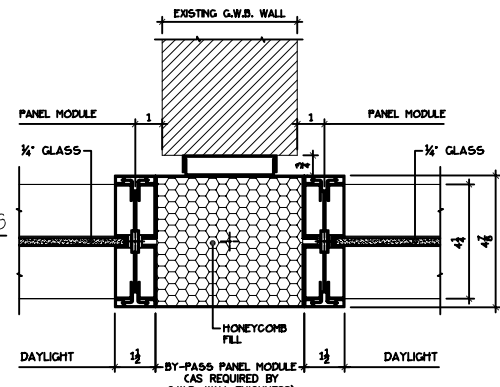

BY-PASS PANEL AT GLASS PANELS